

PRODUCT DATASHEET

SF CIRC 400 SEN V 24W 840 IP44

SURFACE CIRCULAR 400 SENSOR | Wall and ceiling luminaire with IP44 and high frequency sensor

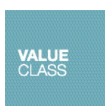

Areas of application

- Corridors
- Stairways
- Bathrooms
- Foyers

Product benefits

- Easy adjustment of sensor range, daylight detection and hold time
- Indoor luminaire with high luminous efficacy
- Energy savings of up to 55 % compared to luminaires that use CFL
- Easy and quick installation
- Very homogenous light
- 3 years guarantee

Product features

- High frequency sensor for daylight and motion detection
- Type of protection: IP44 (ceiling mounting), IP20 (wall mounting)
- Impact resistance: IK03
- Metal housing, PMMA cover
- Ambient temperature in operation: -20...+40 °C
- Indoor use only, not suitable for outdoor use

TECHNICAL DATA

Electrical data

Nominal wattage	24.00 W
Nominal voltage	220...240 V
Mains frequency	50...60 Hz
Nominal current	185 mA
Inrush current	7.3 A
Inrush current time T_{h50}	256 μ s
Max. number of luminaires per miniature circuit breaker B16	35
Max. number of luminaires per miniature circuit breaker C10	35
Max. number of luminaires per miniature circuit breaker C16	56
Power factor λ	> 0.55
Total harmonic distortion	< 120 %
Protection class	I
Operating mode	Integrated LED driver

Photometrical data

Luminous flux	1920 lm
Luminous efficacy	80 lm/W
Color temperature	4000 K
Light color (designation)	Cool White
Color rendering index Ra	> 80
Standard deviation of color matching	< 6 sdc _m
Luminous intensity	-
Low flicker	Yes
Flickering metric (Pst LM)	-
Stroboscope effect metric (SVM)	-
Photobiological safety group acc. to EN62778	RG0
Photobiological safety group acc. to EN62471	RG0
Beam angle	120 °

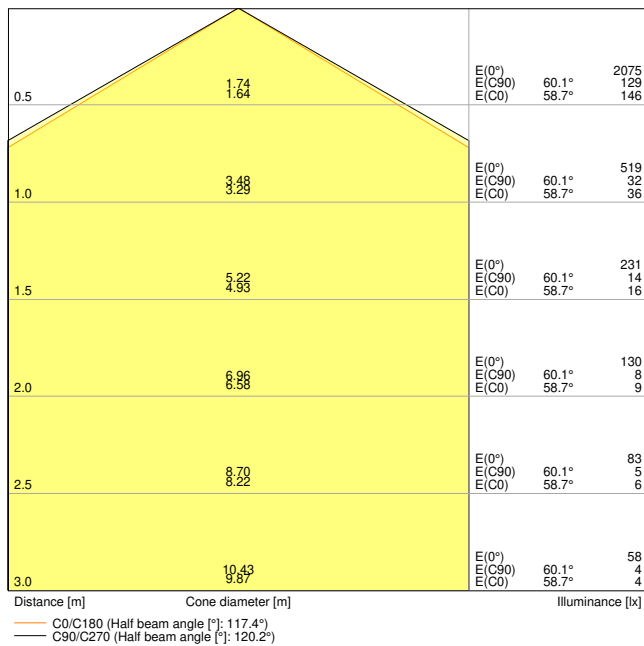

SF CIRC 400 SEN V 24W 840 IP44

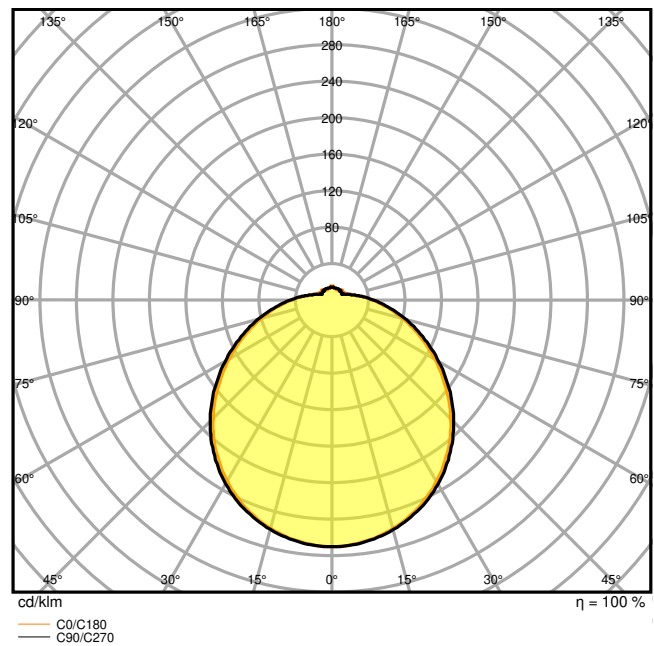

SF CIRC 400 SEN V 24W 840 IP44

Dimensions & Weight

Diameter	400.00 mm
Height	120.00 mm
Product weight	790.00 g

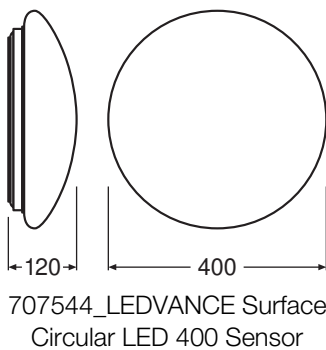

Materials & Colors

Product color	White
Housing color	White
Body material	Steel
Cover material	Polymethylmethacrylate (PMMA)
Light emitting surface material	PMMA

Glow Wire Test according to IEC 60695-2-12	650 °C
Mercury content	0.0 mg

Application & Mounting

Ambient temperature range	-20...+40 °C
Temperature range at storage	-20...+80 °C
Type of connection	Terminal, 3-pin
Type of protection	IP44 ¹⁾
Protection class IK (shock resistance)	IK03
Dimmable	No
Mounting type	Surface
Mounting location	Ceiling / Wall
Application environment	Indoor
LED module replaceable	Not replaceable
With light source	Yes

¹⁾ Type of protection: IP44 (ceiling mounting), IP20 (wall mounting)

Lifespan

Lifespan L70/B50 at 25 °C	30000 h ¹⁾
Lifespan L80/B10 at 25 °C	22000 h ¹⁾
Lifespan L90/B10 at 25 °C	15000 h
Number of switching cycles	50000

¹⁾ t[h]: L70 / B50 @ 25 °C (Ta), t[h]: L80 / B10 @ 25 °C (Ta), t[h]: L90 / B10 @ 25 °C (Ta)

Control gear

Output current	250 mA
----------------	--------

Sensor

Type of sensor	Motion / Light
Sensor technology	Microwave
Sensor detection angle	120 °
Sensor controlled switching time	5 s...30 min
Detection range of motion sensor	4...7 m
Detection threshold of daylight sensor	2...50 lx
Sensor IP rating	IP44

Certificates & Standards















Standards	CE / CB / TÜV SÜD / EAC / EPD
Luminaire with limited surface temperature, "D sign"	No

Ball shot safe	No
EPD	LEDV-00010-V01.01-EN

EQUIPMENT / ACCESSORIES

– Replacement cover optional available

DOWNLOAD DATA

Documents and certificates		Document name
	User instruction	SURFACE CIRCULAR SENSOR
	Addon Technical Information	LS Insert SF Circular
	Addon Technical Information	LS Insert SF Circular
	Packaging insert	Legal Insert SF CIRC SEN V IP44
	Declarations Of Conformity CE	CE Declaration SF CIRC SEN
	Declarations Of Conformity UKCA	SF CIRC IP44
Photometric and lighting design files		Document name
	IES file (IES)	SF CIRC 400 SEN V 24W 840 IP44
	LDT file (Eulumdat)	SF CIRC 400 SEN V 24W 840 IP44
	ULD file (DIALux)	SF CIRC 400 SEN V 24W 840 IP44
	ROLF file (RELUX)	SF CIRC 400 SEN V 24W 840
	UGR file (UGR table)	SF CIRC 400 SEN V 24W 840 IP44
	LDC typ cone	SF CIRC 400 SEN V 24W 840 IP44
	LDC typ polar	SF CIRC 400 SEN V 24W 840 IP44
CAD/BIM files		Document name
	BIM_Revit_3D	SURFACE CIRCULAR
	CAD_STEP_3D	SF CIRC 400

Tender texts	Document name
 Tender documents	SURFACE CIRCULAR 400 SENSOR 24W 840 IP44-EN

LOGISTICAL DATA

Product code	Packaging unit (Pieces/Unit)	Dimensions (length x width x height)	Gross weight	Volume
4058075618121	Folding box 1	130 mm x 440 mm x 440 mm	912.00 g	25.17 dm ³
4058075618138	Shipping box 5	665 mm x 455 mm x 460 mm	5866.00 g	139.18 dm ³

The mentioned product code describes the smallest quantity unit which can be ordered. One shipping unit can contain one or more single products. When placing an order, for the quantity please enter single or multiples of a shipping unit.

ADDITIONAL CATALOG INFORMATION

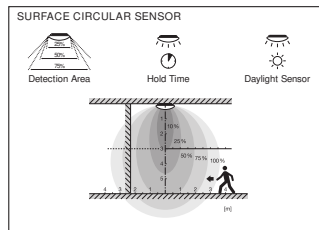
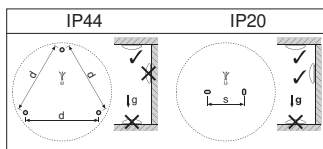

References / Links

– For Guarantee see www.ledvance.com/guarantee

DISCLAIMER

Subject to change without notice. Errors and omission excepted. Always make sure to use the most recent release.