

# PRODUCT DATASHEET

## SL FLEX SM RV25ST P 13W 740 WAL

STREETLIGHT FLEX SMALL RV25ST | Light distribution for general road lighting



PERFOR-  
MANCE  
CLASS

### Areas of application

- Outdoor use (IP66)
- M-, C- and P-class roads acc. to EN 13201
- Parking
- Public areas
- Industry

### Product benefits

- Durable design and highest quality component selection for long lasting performance
- Quick and easy wiring, due to tool-free housing opening and push button terminal
- High light uniformity
- 3 light colors available, perfectly suited to illuminate highly diverse surroundings
- No upper light output ratio (ULOR 0%) when mounted at 0° tilt
- Automatic mains disconnection when opening the housing
- 5 years guarantee

### Product features

- Light distributions optimized for streets of similar width to the pole height
- Very long lifetime (L90/B10): Up to 100,000 h (at 25 °C)
- Spigot for 48-60 mm poles included
- Additional reduction for 42 mm and adapter for 76 mm poles available separately
- Adjustable spigot for both side-entry and post-top installation
- +/- 15° tilt angle adjustment without opening the housing



- High luminous efficacy: up to 144 lm/W
- Operating temperature: -40...50 °C
- High surge protection: up to 10 kV (L/N-GND)
- Protection class: II

## TECHNICAL DATA

### Electrical data

Nominal wattage	13.00 W
Nominal voltage	220...240 V
Mains frequency	50...60 Hz
Nominal current	60 mA
Inrush current	25 A
Inrush current time $T_{h50}$	150 $\mu$ s
Max. number of luminaires per miniature circuit breaker B16	36
Max. number of luminaires per miniature circuit breaker C10	40
Max. number of luminaires per miniature circuit breaker C16	70
Power factor $\lambda$	> 0.90
Total harmonic distortion	< 10 %
Protection class	II
Operating mode	Integrated LED driver

### Photometrical data

Luminous flux	1780 lm
Luminous efficacy	137 lm/W
Color temperature	4000 K
Light color (designation)	Cool White
Color rendering index Ra	70
Standard deviation of color matching	< 5 sdc <sub>m</sub>
Low flicker	Yes
Photobiological safety group acc. to EN62778	RG1
Photobiological safety group acc. to EN62471	RG1
Beam angle	25 ° x 145 °

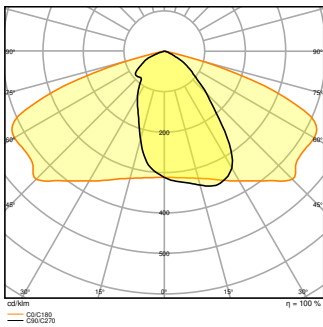

SL FLEX SM P 13W 740 RV25ST  
WAL

### Dimensions & Weight

Length	445.00 mm
Width	250.00 mm
Height	90.00 mm
Product weight	4400.00 g

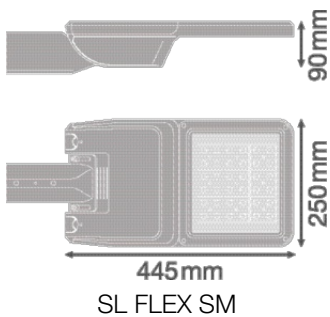

### Materials & Colors

Product color	White aluminum
Housing color	White aluminum
Body material	Aluminum
Cover material	Tempered glass
Light emitting surface material	Glass
Glow Wire Test according to IEC 60695-2-12	650 °C

### Application & Mounting

Ambient temperature range	-40...+50 °C
Temperature range at storage	-30...+80 °C
Type of connection	Screwless terminal
Type of protection	IP66
Protection class IK (shock resistance)	IK08
Dimmable	No
Mounting type	Post top
Mounting location	Pole
Application environment	Outdoor
Adjustable	Yes
LED module replaceable	Not replaceable
With light source	Yes

### Lifespan

Lifespan L70/B50 at 25 °C	100000 h <sup>1)</sup>
Lifespan L80/B10 at 25 °C	100000 h <sup>1)</sup>
Lifespan L90/B10 at 25 °C	100000 h
Number of switching cycles	100000

<sup>1)</sup> t[h]: L70 / B50 @ 25 °C (Ta), t[h]: L80 / B10 @ 25 °C (Ta), t[h]: L90 / B10 @ 25 °C (Ta)

### Control gear

Output current	480 mA
ECG - Output ripple current	≤ 10 %

### Certificates & Standards

Standards	CE / ENEC / EAC
Luminaire with limited surface temperature, "D sign"	No
Ball shot safe	No

### Accessories Optional





Product image	Product name	EAN
	SL FLEX SPIGOT 76MM WAL	4058075552531





Product image	Product name	EAN
	SL FLEX REDUCTION 60 TO 42MM WAL	4058075552579

**EQUIPMENT / ACCESSORIES**

– Spigot for 42 and 76 mm poles available separately

**DOWNLOAD DATA**

Documents and certificates		Document name
	User instruction	SL FLEX WAL
	Addon Technical Information	LSI SL FLEX LA P
	Packaging insert	Legal insert SL FLEX WAL
	Declarations Of Conformity CE	SL FLEX MD
	Declarations Of Conformity UKCA	SL FLEX WAL

Photometric and lighting design files		Document name
	IES file (IES)	SL FLEX SM P 13W 740 RV25ST WAL
	LDT file (Eulumdat)	SL FLEX SM P 13W 740 RV25ST WAL
	ULD file (DIALux)	SL FLEX SM P 13W 740
	ROLF file (RELUX)	SL FLEX SM P 13W 740
	LDC typ polar	SL FLEX SM P 13W 740 RV25ST WAL

CAD/BIM files		Document name
	BIM_Revit_3D	SL FLEX SM

CAD/BIM files		Document name
	CAD_STEP_3D	SL_FLEX_SM

---

Tender texts		Document name
	Tender documents	STREETLIGHT FLEX SMALL RV25ST P 13W 740 WAL-EN

**LOGISTICAL DATA**

Product code	Packaging unit (Pieces/Unit)	Dimensions (length x width x height)	Gross weight	Volume
4058075552258	Shipping box 1	502 mm x 330 mm x 235 mm	5235.00 g	38.93 dm <sup>3</sup>

The mentioned product code describes the smallest quantity unit which can be ordered. One shipping unit can contain one or more single products. When placing an order, for the quantity please enter single or multiples of a shipping unit.

**ADDITIONAL CATALOG INFORMATION**

**References / Links**

– For Guarantee see [www.ledvance.com/guarantee](http://www.ledvance.com/guarantee)

**DISCLAIMER**

Subject to change without notice. Errors and omission excepted. Always make sure to use the most recent release.