

PRODUCT DATASHEET

SPOT SQUARE DK ADJ 8 W 3000 K WT

SPOT SQUARE DARKLIGHT ADJUST | Recessed mounted spotlight, adjustable, square shape



PERFOR-
MANCE
CLASS

Areas of application

- Replacement of halogen lamp spotlights
- General accent lighting
- Shops, boutiques
- Hotel rooms
- Bars, restaurants
- Galleries, museums
- Residential interiors

Product benefits

- Cut off angle for comfortable indoor lighting
- High luminous efficacy
- Die-cast aluminum housing for improved heat dissipation
- Energy savings of up to 90 % compared to halogen lamp spotlights
- External driver for extended flexibility (compatible with selected DALI drivers)
- Easy replacement of external driver thanks to plug with bayonet lock
- Design matches the LEDVANCE Spot-, Down- and Tracklight luminaire family
- 5 years guarantee

Product features

- Adjustable tilt angle: +/- 20°
- Initial color consistency: ≤ 4 SDCM



– Lens material: PMMA

TECHNICAL DATA

Electrical data

Nominal wattage	8.00 W
Nominal voltage	220...240 V
Mains frequency	50...60 Hz
Nominal current	65 mA
Inrush current	23 A
Inrush current time T_{h50}	< 3.4 μ s
Max. number of luminaires per miniature circuit breaker B16	32
Max. number of luminaires per miniature circuit breaker C10	26
Max. number of luminaires per miniature circuit breaker C16	41
Power factor λ	> 0.5
Total harmonic distortion	< 15 %
Protection class	II
Operating mode	External LED driver

Photometrical data

Luminous flux	650 lm
Luminous efficacy	90 lm/W
Color temperature	3000 K
Light color (designation)	Warm White
Color rendering index Ra	> 80
Standard deviation of color matching	≤ 4 sdc _m
Luminous intensity	-
Low flicker	Yes
Flickering metric (Pst LM)	-
Stroboscope effect metric (SVM)	-
Photobiological safety group acc. to EN62778	RG0
Photobiological safety group acc. to EN62471	RG0
Beam angle	36 °

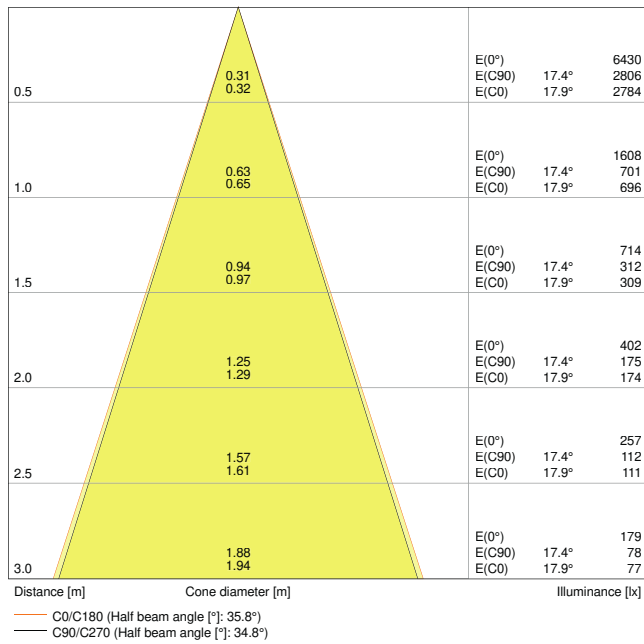

SP SQUARE DK ADJ 8W3000K FL WT

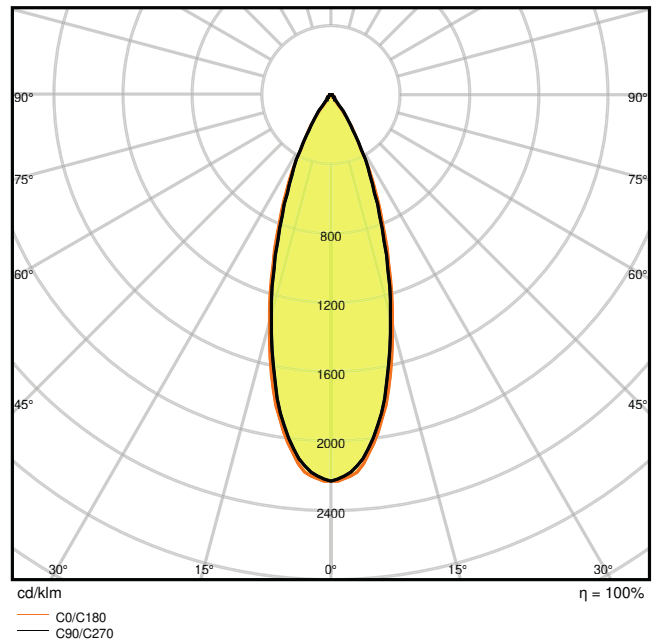

SP SQUARE DK ADJ 8W3000K FL WT

Dimensions & Weight

Length	90.00 mm
Width	90.00 mm
Height	72.00 mm
Product weight	230.00 g

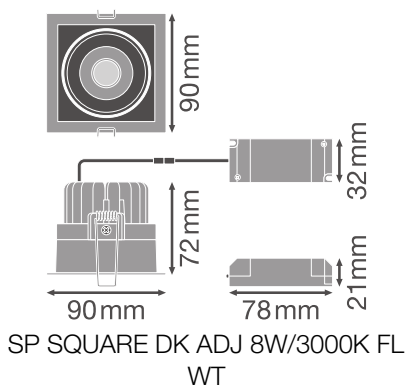

Materials & Colors

Product color	White
Housing color	White
Body material	Aluminum
Cover material	Polymethylmethacrylate (PMMA)
Glow Wire Test according to IEC 60695-2-12	650 °C

Application & Mounting

Ambient temperature range	-10...+40 °C
Type of connection	Screw terminal, 2-Pole (L,N)
Type of protection	IP20
Protection class IK (shock resistance)	IK03
Dimmable	No
Mounting type	Recessed
Mounting location	Ceiling
Application environment	Indoor
Mounting length	83 mm
Mounting width	83 mm
Mounting depth	90 mm
Adjustable	Yes
LED module replaceable	Not replaceable
With light source	Yes

Lifespan

Lifespan L70/B50 at 25 °C	50000 h ¹⁾
Lifespan L80/B10 at 25 °C	45000 h ¹⁾
Lifespan L90/B10 at 25 °C	30000 h
Number of switching cycles	50000

¹⁾ t[h]: L70 / B50 @ 25 °C (Ta), t[h]: L80 / B10 @ 25 °C (Ta), t[h]: L90 / B10 @ 25 °C (Ta)

Control gear

ECG - Length	78 mm
ECG - Width	32 mm
ECG - Height	21 mm

Certificates & Standards









Standards	CE / TÜV SÜD / RoHS / ENEC
-----------	----------------------------



Luminaire with limited surface temperature, "D sign"	No
Ball shot safe	No

EQUIPMENT / ACCESSORIES

– Driver included

DOWNLOAD DATA

Documents and certificates		Document name
	User instruction	UI Spot Square DK
	Addon Technical Information	LSI SP SQUARE DK ADJ
	On-Pack-Info	Legal Insert Spot LED
	Declarations Of Conformity CE	EU Declaration of Conformity Spot Square 8W LEDV
	Declarations Of Conformity CE	Attestation-of-Conformity SP SQ and Multi TÜV
	Declarations Of Conformity UKCA	SP MULTI FL / SP SQUARE DK ADJ FL
Photometric and lighting design files		Document name
	IES file (IES)	SP SQUARE DK ADJ 8W3000K FL WT
	LDT file (Eulumdat)	SP SQUARE DK ADJ 8W3000K FL WT
	ULD file (DIALux)	SPOTSQUAREDARKLIGHTADJUST8W3000KWT
	ROLF file (RELUX)	SP SQUARE DK ADJ
	UGR file (UGR table)	SP SQUARE DK ADJ 8W3000K FL WT
	LDC typ cone	SP SQUARE DK ADJ 8W3000K FL WT
	LDC typ polar	SP SQUARE DK ADJ 8W3000K FL WT

CAD/BIM files		Document name
	BIM_Revit_3D	SPOT SQUARE DARKLIGHT ADJUST
	CAD_STEP_3D	SP SQUARE DK ADJ

Tender texts		Document name
	Tender documents	SPOT SQUARE DARKLIGHT ADJUST 8 W 3000 K WT-EN

LOGISTICAL DATA

Product code	Packaging unit (Pieces/Unit)	Dimensions (length x width x height)	Gross weight	Volume
4058075114043	Folding box 1	105 mm x 110 mm x 115 mm	265.00 g	1.33 dm ³
4058075114050	Shipping box 6	345 mm x 115 mm x 245 mm	1795.00 g	9.72 dm ³

The mentioned product code describes the smallest quantity unit which can be ordered. One shipping unit can contain one or more single products. When placing an order, for the quantity please enter single or multiples of a shipping unit.

ADDITIONAL CATALOG INFORMATION

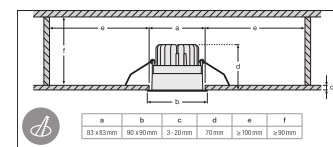
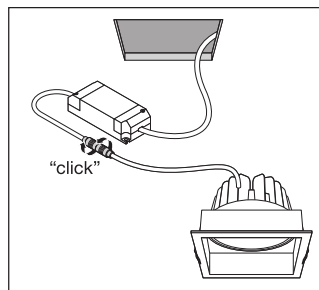
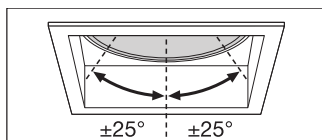

References / Links

– For Guarantee see www.ledvance.com/guarantee

DISCLAIMER

Subject to change without notice. Errors and omission excepted. Always make sure to use the most recent release.