

LED Bathroom mirror luminaire

LED Bathroom mirror luminaire, IP44, with microwave sensor for presence and daylight detection and Vario Flex technology. Colour Rendition > 90 for best lighting quality, opal diffusor for homogenous lighting. Total luminous flux: 1200 lm. Luminaire input power: 12 W. Luminaire efficacy: 100 lm/W. Colour rendering Ra > 90, colour temperature 3000/3500/4000 K, adjustable via switch. Lifetime: 50.000hrs @L70. Chromaticity tolerance (initial MacAdam): 4. Impact strength: IK08. FLEX technology allows to adjust the input power on site by 2 steps (FLEX1: 1200 lm (12W), FLEX2: 900 lm (9W)). For flex data on other colour temperatures please visit website. Dimensions: 600 x 59 x 81 mm, weight: 0.85 kg.

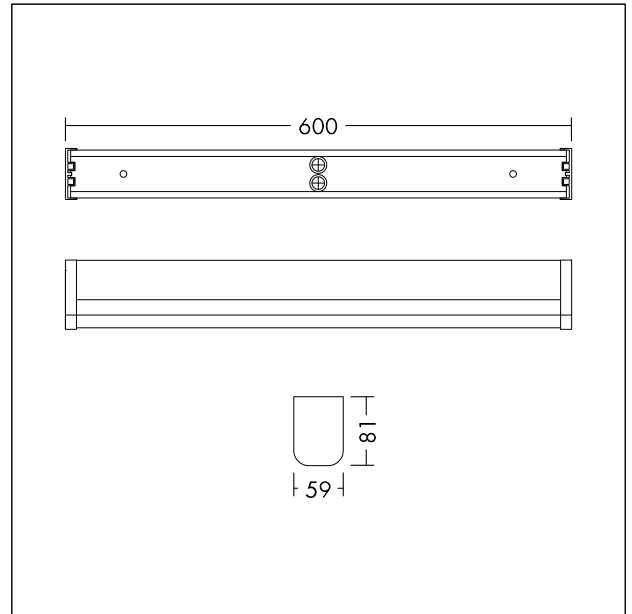

TE_ELSA_F_600_PERSP_NO_SWITCH.jpg



TE_ELSAVARIOFLEX_M_600.wmf

Light Distribution

STD - standard

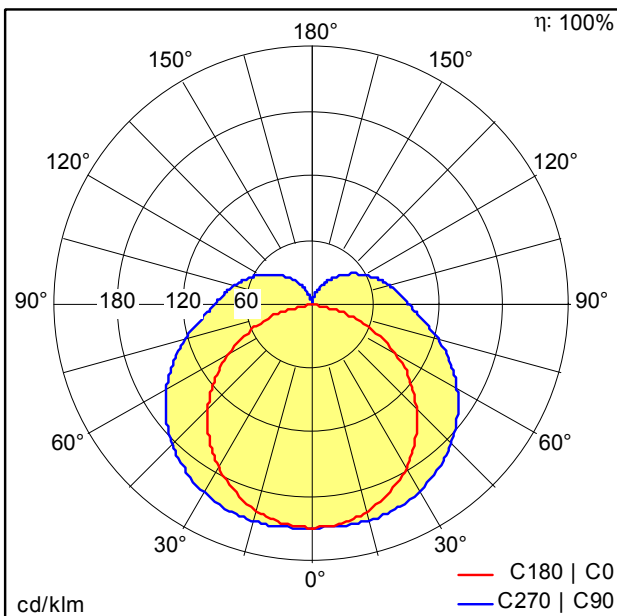

TE_ELSA_VARIOFLEX_600_1200_940_FLEX1.idt

- Light Source: LED
- Luminaire luminous flux*: 1200 lm
- Luminaire efficacy*: 100 lm/W
- Colour Rendering Index min.: 90
- Correlated colour temperature*: 3000-4000 Kelvin
- Chromaticity tolerance (initial MacAdam): 4
- Rated median useful life*: L70 50000h at 25°C
- Ballast: 1x LED_Con
- Luminaire input power*: 12 W Power factor = 0.9
- Dimming: Fixed output
- Maintenance category: D - Enclosed IP2X
- Total harmonic distortion (THD): 20.00 %

This product contains a light source of energy efficiency class E.

All values marked with an * are rated values. Luminous flux and connected electrical load are subject to an initial tolerance of +/- 10%. Unless stated otherwise, the values apply to an ambient temperature of 25°C.